

SERIES 3

# FLiteboard

User Guide

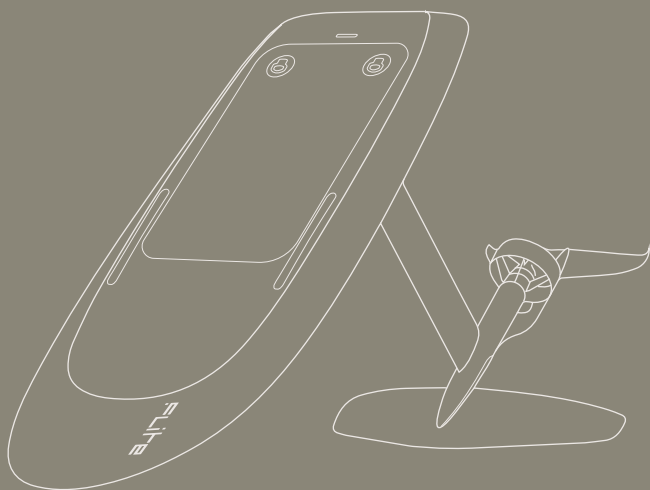





## Important

IN ORDER TO OPERATE THE PRODUCT CORRECTLY AND MINIMISE THE CHANCES OF DAMAGE, SERIOUS INJURY OR DEATH, IT IS ESSENTIAL TO READ AND FOLLOW ALL OF THE INSTRUCTIONS AND WARNINGS IN THE USER GUIDE PRIOR TO ASSEMBLY, SETUP OR USE. BY USING A FLITEBOARD YOU AGREE THAT YOU DO SO AT YOUR OWN RISK.

CAUTION: THIS PRODUCT HAS BEEN KNOWN TO DRAMATICALLY IMPROVE YOUR LIFE AND HAPPINESS LEVELS.



For the latest version and translations of this guide visit

[fliteboard.com/support](https://fliteboard.com/support)



Watch our video tutorials at

[fliteboard.com/video](https://fliteboard.com/video)



Authorised Flite Service, Resellers and Fliteschools

[fliteboard.com/locations](https://fliteboard.com/locations)



Download the Flite App

[fliteboard.com/app](https://fliteboard.com/app)



Fliteboard support

[fliteboard.com/support](https://fliteboard.com/support)



Fliteboard contact

[fliteboard.com/contact](https://fliteboard.com/contact)



Material Safety Data Sheets

[fliteboard.com/MSDS](https://fliteboard.com/MSDS)



Ready to fly post storage checklist

[fliteboard.com/readytoflychecklist](https://fliteboard.com/readytoflychecklist)



6 Month Flitecell Checklist

[fliteboard.com/flitecellchecklist](https://fliteboard.com/flitecellchecklist)



## Safety and Disclaimer

All safety and disclaimer information is subject to change at the sole discretion of Fliteboard. For up-to-date product information visit [fliteboard.com/support](https://fliteboard.com/support)

## Warning

Failure to operate this product in a safe and responsible manner could result in injury or death to yourself or others and/or damage to the Fliteboard or other's property.

THIS PRODUCT MUST BE OPERATED WITH CAUTION AND COMMON SENSE AND REQUIRES SOME BASIC MECHANICAL ABILITY.

FLITEBOARD IS NOT INTENDED FOR USE BY CHILDREN UNDER 16 YEARS OF AGE, SUBJECT TO LOCAL LAWS AND REGULATIONS.

DO NOT USE WITH INCOMPATIBLE COMPONENTS OR ALTER THIS PRODUCT IN ANY WAY OUTSIDE OF THE DOCUMENTS PROVIDED BY FLITEBOARD.

FLITEBOARD IS NOT A TOY. EXERCISE CAUTION. ACT RESPONSIBLY WHILE OPERATING.

CONSIDER THE SAFETY OF YOUR ENVIRONMENT BEFORE OPERATING FLITEBOARD. DO NOT RIDE IN SHALLOW WATER (LESS THAN 1.5M IN DEPTH), ROCKY AREAS OR IN SEVERE WEATHER CONDITIONS.

IT MAY BE NECESSARY TO OBTAIN A LICENCE OR PERMIT TO USE A FLITEBOARD IN CERTAIN STATES OR COUNTRIES.

## Intended use

Fliteboard is for operation by one person only, who should be over the age of 16 (or as local laws apply). It is not designed for passengers or towing of objects or people.

Fliteboard must travel at a safe speed so that Fliteboard can be stopped in time to avoid any danger which may suddenly arise. When judging a safe speed, you must consider a number of factors – visibility, other vessels, navigation hazards, wind, waves and currents, waterway width and the manoeuvrability of your vessel.

For your safety and that of others, please ensure that you obtain proper training or practice before operating Fliteboard yourself.

This User Guide does not provide boating safety or seamanship advice. Please consult local laws and guidelines for boating safety.

If you have any questions about the operation or maintenance of Fliteboard, please consult Fliteboard technical support, or an Authorised Flite Reseller.

This User Guide should be considered a permanent part of Fliteboard and should remain with it even if it is subsequently sold.

## Propulsion system

The Fliteboard propulsion system includes a powerful spinning Flite Propeller or Flite Jet.

KEEP BODY, FINGERS AND TOES AWAY FROM THE FLITEBOARD'S SPINNING PROPELLER OR IMPELLER. CONTACT WITH THE PROPELLER OR IMPELLER WILL CAUSE SERIOUS INJURY OR DEATH.

NEVER TOUCH THE PROPELLER OR IMPELLER IN OR OUTSIDE OF THE WATER.

NEVER HANDLE THE PROPELLER OR IMPELLER WHILE THE FLITECELL IS CONNECTED.

ALWAYS FLITEBOARD A SAFE DISTANCE FROM OTHER WATERCRAFT, SWIMMERS, SURFERS, DIVERS AND WILDLIFE.

NEVER FLITEBOARD IN SEAWEED OR CONTAMINATED WATER.

## Hydrofoil safety

The Fliteboard hydrofoil system comprises a mast (or strut), a main wing and stabiliser wing. These components include sharp trailing edges and wing tips. Take care not to kick or hit the sharp edges when in the water.

FALLING ON THE HYDROFOIL CAN CAUSE SERIOUS INJURY OR DEATH.

WE ALWAYS RECOMMEND YOU WEAR APPROPRIATE SAFETY GEAR WHEN FLITEBOARDING, INCLUDING AN APPROVED IMPACT VEST / PFD AND HELMET. CHECK YOUR LOCAL REGULATIONS TO CONFIRM IMPACT VEST / PFD AND HELMET REQUIREMENTS. REFER TO THE MANUFACTURER'S DOCUMENTATION ON SAFETY, CARE AND MAINTENANCE GUIDELINES FOR YOUR IMPACT VEST / PFD AND HELMET.

TAKE CARE TO LEARN STEP BY STEP, FOLLOWING THE INSTRUCTIONS IN THIS GUIDE AND THE FLITEBOARD VIDEO TUTORIALS AT [fliteboard.com/video](https://fliteboard.com/video)

## Learning to Fliteboard

We recommend learning to Fliteboard with an instructor at an authorised Fliteschool. Fliteschool locations can be found at [fliteboard.com/locations](https://fliteboard.com/locations)

PLEASE VIEW OUR HOW TO FLITEBOARD VIDEO AT [fliteboard.com/video](https://fliteboard.com/video) TO LEARN THE PROPER TECHNIQUE AND REVIEW RIDING SAFETY INFORMATION.

FLITEBOARD IS NOT SUITABLE FOR RIDING BREAKING WAVES IN THE SURF ZONE. RIDERS DO SO AT THEIR OWN RISK. FLITEBOARD SHOULD NEVER BE RIDDEN NEAR OTHER WATER USERS (INCLUDING SWIMMERS AND SURFERS) OR OFFSHORE FROM SWIMMERS AND SURFERS (IN CASE FLITEBOARD IS PUSHED TOWARDS SHORE IN A WAVE).

FLITEBOARDING CAN BE EASY WHEN PROPER TECHNIQUE IS APPLIED. INCORRECT TECHNIQUE CAN RESULT IN INJURY OR DAMAGE.

## Important rider safety

### 1 Read the User Guide and watch the How to Fliteboard video

Before attempting to Fliteboard for the first time, read this User Guide and pay special attention to the warnings and disclaimers. Most injuries can be avoided by using proper technique when learning. Watch the How to Fliteboard video at [fliteboard.com/video](http://fliteboard.com/video)



### 2 Wear a helmet and Impact Vest / PFD

Wear an approved and certified helmet and impact vest / PFD (Personal Flotation Device) at all times.

There may be specific rules and legal requirements in your location that also apply.



### 3 Avoid contact with the wings and propeller

Avoid contact with the wings, mast and propeller which all have sharp edges. Take care to not kick the wings when climbing on to the board.

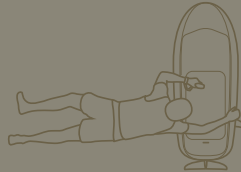



## 5 Keep distance

Keep well clear of other water users at all times. Check regulations for vessel operating distance rules in your area. Always be on the lookout for swimmers, divers, other vessels or obstacles when riding; they may be obscured by waves or glare.

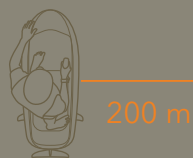

## 6 Release the throttle

Release the throttle trigger immediately on committing yourself to a fall. This will stop the motor and reduce the forces which could otherwise lead to a more extreme crash. Practice this skill when learning with the goal of stopping the motor before you hit the water in a fall.

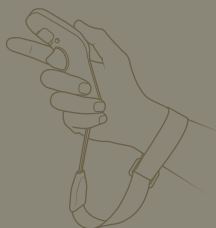

## 7 Fall away from Fliteboard

The best way to avoid injury is to practice the correct falling technique. As soon as you begin to lose balance, purposely fall in the direction the board is already falling. You will then likely end up in the water on the opposite side to the hydrofoil assembly. Like being on stilts, it is impossible to regain balance once your weight is no longer above the hydrofoil wings (unless you are turning).

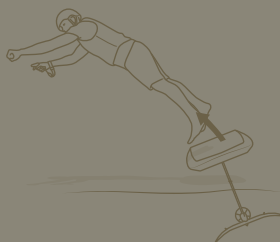



## Warranty

Fliteboard comes with a Limited Warranty which covers defects in materials or workmanship of the product and aligns to relevant consumer laws of the location of purchase. Further details about the Fliteboard Limited Warranty are set out in your Purchase Agreement.

For our Australian customers: Our goods come with guarantees that cannot be excluded under the Australian Consumer Law. You are entitled to a replacement or refund for a major failure and compensation for any other reasonably foreseeable loss or damage. You are also entitled to have the goods repaired or replaced if the goods fail to be of acceptable quality and the failure does not amount to a major failure. Please ensure that you complete the Warranty Registration/Details of Purchase card at the end of this User Guide.

## Maintaining your Warranty

Fliteboard is much more than a surfboard. Similar to any other electric powered vehicle, it needs to be serviced regularly and maintained to ensure good working order and to prevent breakage.

In order to maintain the above warranty, **a mandatory initial 100 hrs / 1 year service of the eFoil is required.**

Only an Authorised Service Partner or Fliteboard HQ can carry out the mandatory initial service, any ongoing yearly / 100 hrs service, warranty repairs and non-warranty repairs. To find your nearest Service Partner, visit [fliteboard.com/locations](https://fliteboard.com/locations)

Fliteboard has been extensively tested with riders weighing up to 120kg / 265lbs. Our specified limit for warranty is 120kg / 265lbs for Fliteboard, AIR and PRO, and 100kg / 220lbs for ULTRA / L.

Information about recommended wing and board combinations for beginner and experienced riders, and lighter and heavier riders, can be found at [fliteboard.com/support](https://fliteboard.com/support)

## Initial 100 hrs / 1 year service

This is to check seals, oil, overall inspection of the eFoil system, Flitecell health and Flite Controller.

Carefully pack the eFoil and Flite Controller in the original eFoil Travel Bag including foam inserts. Send to an Authorised Service Partner or Fliteboard HQ (whichever is closest). Flitecell, wings, chargers or other accessories are not required and should not be included.

Please refer to our 'Packing your Fliteboard' video and help documentation via [fliteboard.com/support](https://fliteboard.com/support)

**The Fliteboard Limited Warranty is void if your Fliteboard has missed the required service schedule.**

## Repairs

If subjected to damage the Fliteboard, PRO and ULTRA / L can be repaired by your local surfboard repair specialist. The inflatable Fliteboard AIR may be repaired using the included repair kit.

## Shipping compliance

Shipping batteries can be illegal and dangerous if not done in accordance with dangerous goods shipping regulations. Always consult an appropriate specialist before shipping your Flitecell. Refer to the included MSDS regarding shipping your Flitecell by sea.

## What's in the box

You will receive your Fliteboard in five separate shipment packages.

### Box 1 Fliteboard

Within the board bag you will find Fliteboard, PRO, ULTRA / L or AIR, depending on your choice.



Fliteboard ULTRA / L travel bag



Fliteboard ULTRA / L

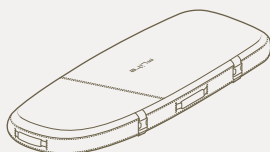

Fliteboard PRO travel bag

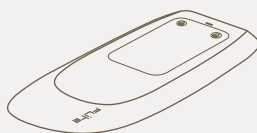

Fliteboard PRO

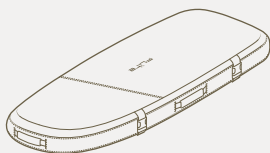

Fliteboard travel bag

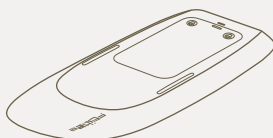

Fliteboard

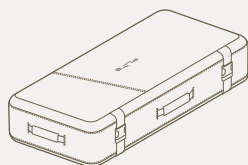

Fliteboard AIR travel bag

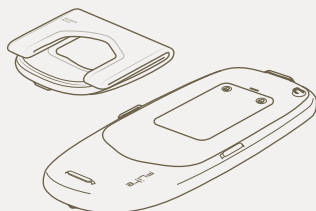

Fliteboard AIR

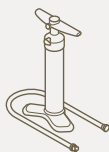

Fliteboard AIR pump and hose



Fliteboard AIR core

## Box 2 Flitecell

Within the included padded Flitecell bag you will find Flitecell Explore, Flitecell Sport or Flitecell Nano, depending on your choice.

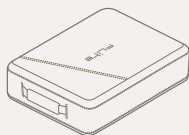

Flitecell travel bag

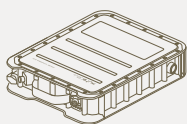

Flitecell Explore

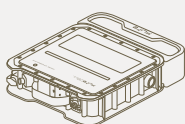

Flitecell Sport  
+ spacer

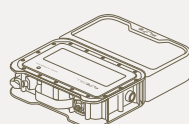

Flitecell Nano  
+ spacer

## Box 3 Charger

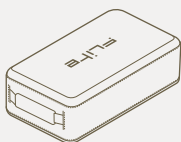

Flitecell Charger  
travel bag

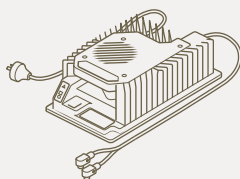

Flitecell Fast  
Charger

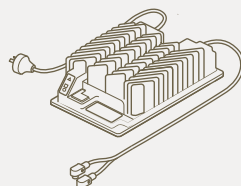

Flitecell Charger

## Box 4 Flite eFoil travel bag

Within the included travel case you will find the eFoil system (length depending on choice) and accessories pouch.



### eFoil travel bag

eFoil system

Fuselage tail + O-Ring

Ring Nut tool

Shoulder strap

Accessories pouch

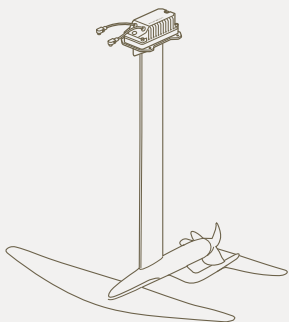

### eFoil System Flite True Glide Propeller

80cm / 31.5 inches

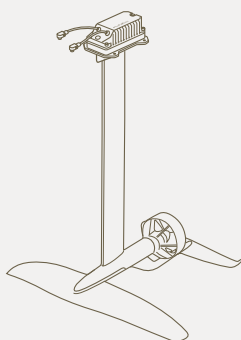

### eFoil System Flite Propeller and Prop Guard

75cm / 29.5 inches

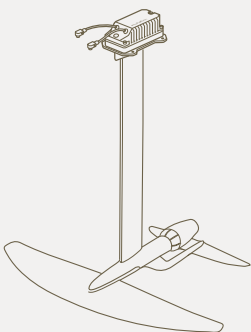

### eFoil System Flite Jet

75cm / 29.5 inches

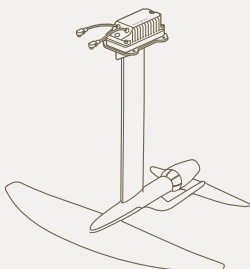

### eFoil System Flite Jet

60cm / 23.6 inches

## Box 4 Accessories pouch

Within the included accessories pouch you will find the following components:

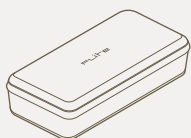

Accessories pouch



Tef-Gel + Brush



Mast Flange  
Seal + spare

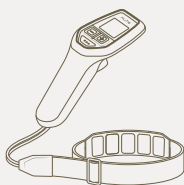

Flite Controller

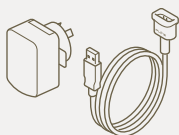

Flite Controller  
USB wall charger  
and charging cable



Stabiliser wing shims  
6 x styles (0-5)



User Guide

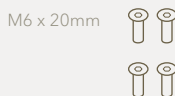

M6 x 20mm  
eFoil Flange bolts



M6 x 16mm  
Tail piece bolt

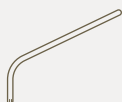

Hex Key M6



Magnetic Clip

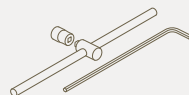

Prop Guard Removal  
Tool Kit

## Box 5 Front wing

Inside the fifth box you will find the front wing of your choice. Each wing comes with a cover, Tef-Gel, Hex Key M6 and associated bolts and Fuselage cover.

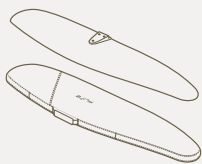

**Cruiser 1800**  
Fuselage cover 1  
1 x M6 x 40mm  
2 x M6 x 35mm



**Cruiser Jet 1800**  
Fuselage cover 2  
1 x M6 x 30mm  
2 x M6 x 25mm



**Cruiser Jet 1500**  
Fuselage cover 2  
1 x M6 x 35mm  
2 x M6 x 30mm

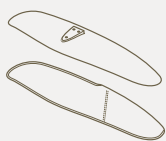

**Cruiser 1100**  
Fuselage cover 1  
1 x M6 x 40mm  
2 x M6 x 35mm

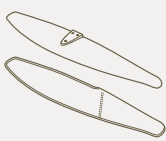

**Flyer 800**  
Fuselage cover 1  
1 x M6 x 30mm  
2 x M6 x 25mm

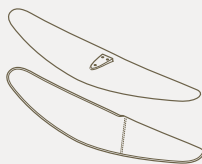

**Flow S 1300**  
Fuselage cover 2  
1 x M6 x 35mm  
2 x M6 x 30mm

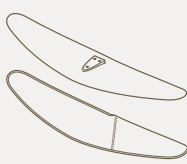

**Flow S 1100**  
Fuselage cover 2  
1 x M6 x 30mm  
2 x M6 x 25mm

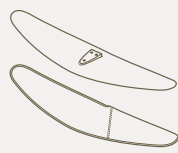

**Flow S 900**  
Fuselage cover 2  
1 x M6 x 25mm  
2 x M6 x 20mm

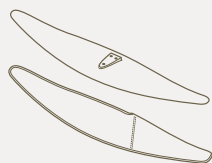

**Flow 1300**  
Fuselage cover 2  
1 x M6 x 35mm  
2 x M6 x 30mm

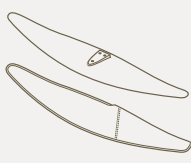

**Flow 1100**  
Fuselage cover 2  
1 x M6 x 30mm  
2 x M6 x 25mm

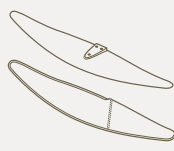

**Flow 900**  
Fuselage cover 2  
1 x M6 x 25mm  
2 x M6 x 20mm

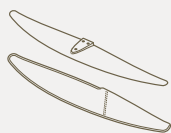

**Race 700**  
Fuselage cover 2  
1 x M6 x 25mm  
2 x M6 x 20mm



## Box 5 Rear stabiliser

In the fifth box you will also find the stabiliser of your choice, with a cover.



**Flite 500**  
2 x M6 x 25mm



**Cruiser Jet 300**  
2 x M6 x 20mm



**Flite 290**  
2 x M6 x 20mm



**Flow 245**  
2 x M6 x 20mm



**Race 200**  
2 x M6 x 20mm

## Getting started

The best way to learn to Fliteboard is to find a Fliteschool in your area. Locate your nearest Fliteschool at [fliteboard.com/fliteschool](http://fliteboard.com/fliteschool)

Watch the Fliteboard video guides at [fliteboard.com/video](http://fliteboard.com/video)

In order to operate the product correctly, avoiding damage or serious injury, it is essential to read and follow all instructions and warnings in the User Guide prior to assembly, setup or use.

IT IS BEST TO ASSEMBLE YOUR BOARD IN A CLEAN, DRY ENVIRONMENT.

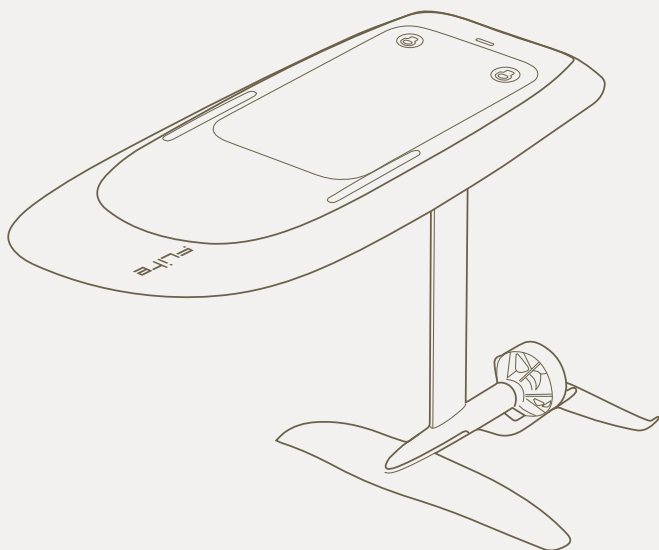

## Charging Flite Controller

- 1 Remove Flite Controller from the accessories pouch, located in the eFoil bag.
- 2 Remove Flite Controller USB Wall Charger and Charging Cable from the accessories pouch.
- 3 Carefully peel out the rubber cover on the underside of Flite Controller. Attach the magnetic charging plug, ensuring the charging pins are connected.
- 4 Plug in the USB Wall Charger and turn on. When the Flite Controller is charging correctly, the screen will show a charging message. Be careful not to disconnect the magnetic charging plug whilst charging. Always check to ensure the Flite Controller is at least 50% charged before each use.

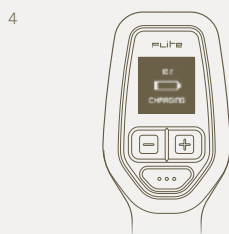
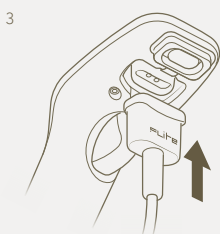
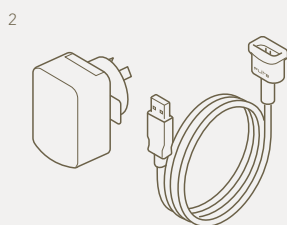

## Flitecell charging procedure

DO NOT COVER THE CHARGER OR INTAKE DURING CHARGING. THE CHARGER SHOULD BE PLACED OUT OF THE REACH OF CHILDREN. CHARGE IN AN INDOOR AREA WITH GOOD VENTILATION AND HEAT DISSIPATION.

DO NOT CHARGE IN HUMID, HIGH TEMPERATURE CONDITIONS. DO NOT CHARGE NEAR FLAMMABLES OR EXPLOSIVES. DO NOT DISASSEMBLE THE CHARGER: THERE IS A DANGER OF HIGH VOLTAGE IN THE CHARGER CASE.

FLITEBOARD DOES NOT BEAR ANY RESPONSIBILITY FOR INCORRECT USE OF THE CHARGER. USERS MUST OPERATE THE CHARGER ACCORDING TO THE USER GUIDE.

ALWAYS KEEP THE RED TERMINAL CAPS ON THE FLITECELL WHEN NOT CONNECTED TO THE BOARD/CHARGER.

## Flitecell Fast Charger

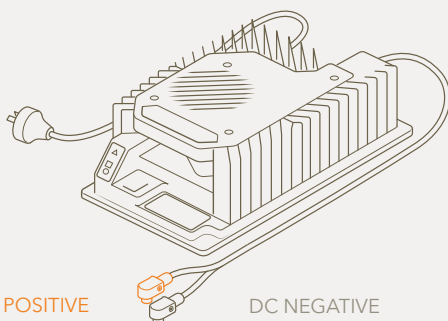

## Flitecell Indicator Guide



Power on



Flashing green

Charging



Solid red

Charger fault

See charger manual



Flashing amber

External error

See charger manual



Flashing green

USB port active

Solid green

Safe to remove USB flash drive

## Charging Flitecell

- 1 Remove Flitecell from its travel bag.
- 2 Place Flitecell in a cool dry location away from flammable or hot items. Safe charging temperatures are 0 - 50°C and optimal charging temperatures are 10 - 30°C.
- 3 Connect Flitecell charger plugs to Flitecell terminals ensuring to connect the orange (positive) connector to the orange terminal first and the black (negative) connector to the black terminal.
- 4 Check that connections have been made correctly. Plug the charger in the wall socket. Place the supplied magnet on the Flitecell for 5 - 10 seconds, as shown by arrow, to activate charging. If the magnet has been misplaced, you can use the base of Flite Controller to initiate charging.
- 5 The charger will automatically turn off when the charging process is complete.

FLITECELL IS A POWERFUL BATTERY CONTAINING A SIGNIFICANT AMOUNT OF ENERGY. CHARGING A DAMAGED FLITECELL CAN RESULT IN A FIRE OR EXPLOSION. ALWAYS INSPECT THE FLITECELL BEFORE CHARGING. CHARGE THE FLITECELL UNDER SUPERVISION, IN A SAFE LOCATION, AWAY FROM DIRECT SUNLIGHT, MOISTURE AND AWAY FROM FLAMMABLE OBJECTS AND SURFACES.

THE BATTERY MANAGEMENT SYSTEM (BMS) BALANCES AND OPTIMISES FLITECELL DURING EACH CHARGE CYCLE.

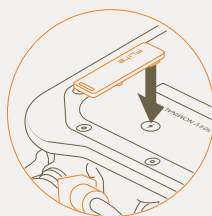
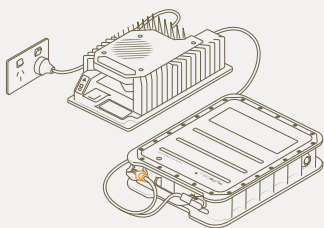

IT IS RECOMMENDED TO DISCONNECT THE FLITECELL AFTER A FULL CHARGING CYCLE.



MAGNET  
PLACED  
TO ACTIVATE  
CHARGING

### Flitecell light

### Light meaning

	Red light flashes Red light on	Capacity 0% - 10% Capacity 10% - 20%
	Green light on Green light flashing	Capacity is 20% - 35% Capacity 20% - 35% + charging
	Two green lights on One on + one flashes	Capacity 35% - 65% Capacity 35% - 65% + charging
	Three green lights on Two on + one flashes	Capacity 65% - 100% Capacity 65% - 100% + charging

## Fliteboard AIR assembly

- 1 Unroll Fliteboard AIR bladder face down.
- 2 Place the rigid core (Flitebox cavity side up) on a flat surface.
- 3 Slide bladder onto core from front end first.

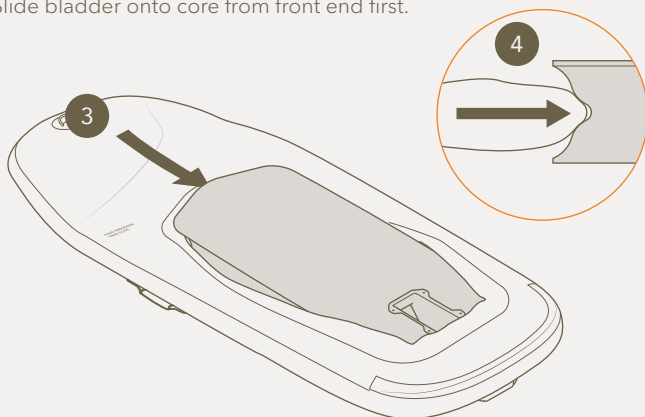

- 4 Ensure bladder is well tucked into the recess along the front edge of the core.
- 5 Carefully stretch bladder over one rear corner first.

NOTE THAT THE REAR UNDERSIDE EDGES OF THE CORE ARE DELIBERATELY SHORTER THAN THE TOP FACE TO MAKE FITMENT OF THE BLADDER EASIER. WARM MILD SOAPY WATER SOLUTION MAY BE APPLIED TO THE AIR BLADDER TO ASSIST WITH FITMENT AND EASE OF ALIGNMENT. RINSE OFF SOAP SOLUTION WITH FRESH WATER AFTER FITMENT IS COMPLETE.

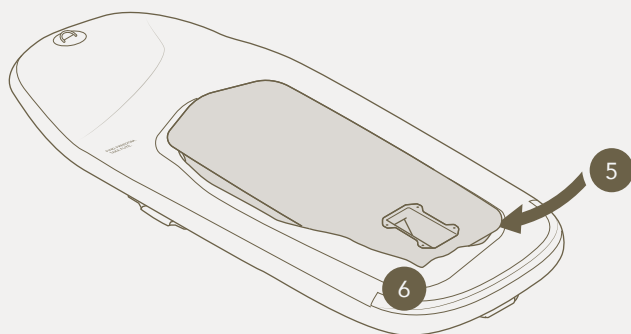

- Stretch the bladder over the other corners. Again, be careful that the bladder is positioned evenly and not creased or caught.
- 6 Check bladder is seated correctly around the core before carefully flipping the Fliteboard AIR over.

PLACE ON A SMOOTH, SOFT SURFACE TO AVOID SCRATCHING THE CARBON FINISH ON THE CORE.

## Inflating Fliteboard AIR

- 1 Twist the valve cap anti-clockwise to remove.
- 2 To inflate, push the central valve down.
- 3 Twist anti-clockwise to release.
- 4 The valve will pop up. This ensures the bladder will not deflate when you remove the hose after inflation.

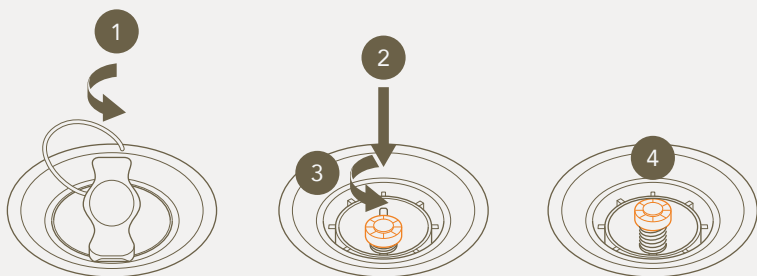

- 5 Connect pump hose to valve and inflate bladder to 15 - 16 PSI.  
THIS IS IMPORTANT FOR OPTIMUM PERFORMANCE AND SAFETY.

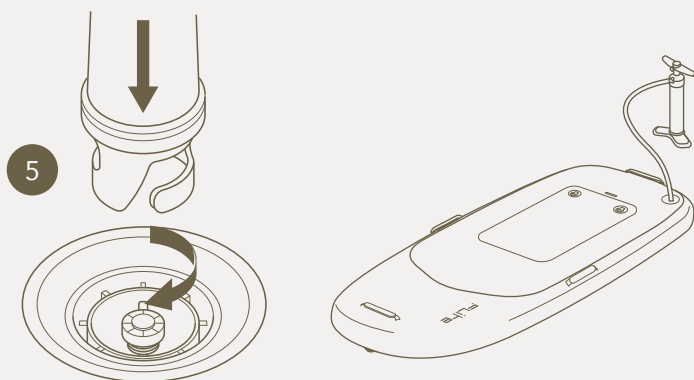

- 6 Once inflated to 15 - 16 PSI, twist the pump hose anti-clockwise to remove and re-fit the valve cover cap. When disconnecting the pump hose, no air should escape from the valve. If the bladder deflates you must release the central valve (see step 2) and re-inflate. Fliteboard AIR is now inflated.

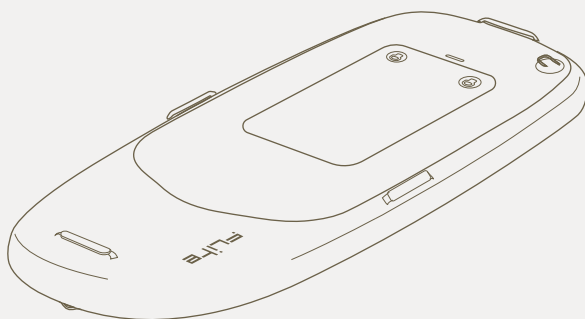

## Connect the eFoil to Fliteboard

- 1 Remove the Fliteboard from its bag and place upside down on the bag or other protective surface. Locate the Flitebox cavity on the bottom of the board and ensure the 4 retaining screws are removed.
- 2 Check to ensure the orange o-ring is inserted, properly seated in the Flitebox cavity o-ring groove, clean and free of sand, grit or water.
- 3 Carefully lift the eFoil from its bag and place the Flitebox into the cavity. While doing this ensure the power cables feed through into the Fliteboard cavity.
- 4 Ensure the Flitebox is properly seated in the cavity and flush with the board surface.
- 5 Add a thin layer of Tef-Gel to the 4 x 20mm stainless steel hex fasteners. Tighten them in a cross pattern, first using your fingers to ensure the threads are properly engaged, and then using the supplied hex key. Use a torque of 6 Nm to tighten the fasteners.
- 6 Medium force needs to be applied when using the long arm of the hex key to ensure the fasteners are tight.
- 7 When properly tightened, the eFoil should be secured and the o-ring compressed. Failure to properly tighten the fasteners or fit the o-ring will result in a board leak.
- 8 Be careful not to over-tighten the fasteners as this could result in stripped threads or damaged fasteners.

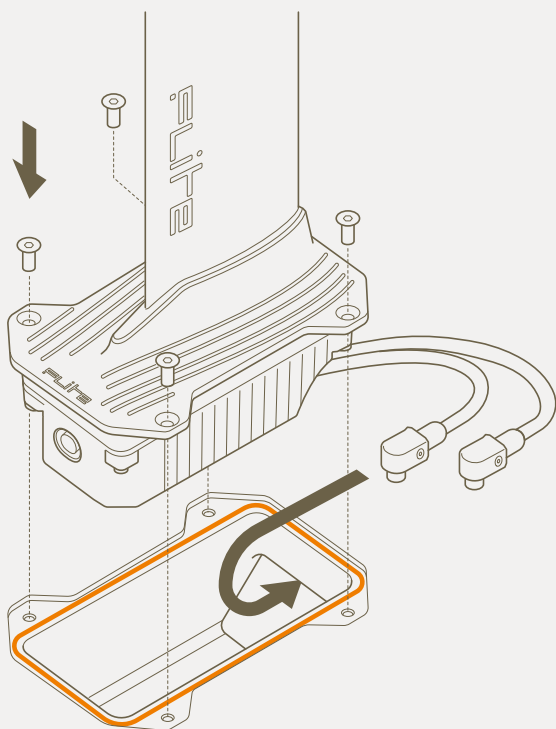



## Dual Drive

Fliteboard's Dual Drive system allows you to swap between the Flite Propeller module with a Pro Tail Cover and Flite Jet quickly and without using tools.

If your Fliteboard has a Prop Guard, you will need to purchase a Pro Tail Cover (which includes the Prop Guard removal tool) from fliteboard.com or your nearest Flite Authorised Partner.

We recommend connecting the eFoil to the Fliteboard first for safer and easier installation.

- 1 Connect the eFoil to the Fliteboard.
- 2 The Dual Drive system uses a reverse thread. Remove the Flite Propeller module by carefully gripping the Pro Tail Cover and rotating **CLOCKWISE**.
- 3 Check the fuselage thread is clean and free of sand, grit or water.
- 4 Check the Flite Jet thread is clean and free of sand, grit or water. Wipe clean if necessary.
- 5 Apply a small amount of Tef-Gel to the thread of the Flite Jet.
- 6 Install the Flite Jet by rotating **ANTI-CLOCKWISE** until there is no gap between the jet and fuselage. This should be just finger tight.
- 7 If there is any resistance during installation, remove the Flite Jet completely to check for sand and grit. Try again without using excessive force. Rotate until the gap is closed.
- 8 Pair the Flite Controller and press the Mode button until the settings screen is displayed. Follow the on-screen instructions to select Jet.
- 9 Check that 'Jet' is displayed on the Speed / Gear screen. Jet mode adjusts the virtual gears for a better experience when Fliteboarding with the Flite Jet.

Add a thin layer of Tef-Gel periodically to the threads of the Flite Propeller module and Flite Jet.

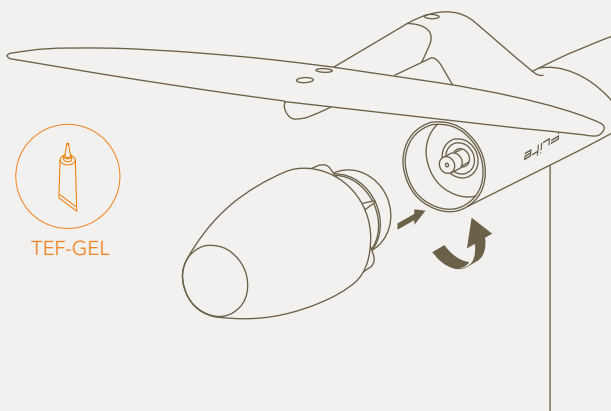

## Connect the fuselage tail

- 1 Place the board upside down with the eFoil connected. Take the fuselage tail from the travel bag, add a light cover of Tef-Gel to the tail connection and install the tail into the fuselage.
- 2 Add a thin layer of Tef-Gel from the tube supplied to the thread of the supplied 16mm fastener bolt and carefully tighten using the hex key using torque of 6 Nm. You may need to push on the tail (compresses the o-ring) for the screw to find the thread. Misalignment may cause damage to the thread.

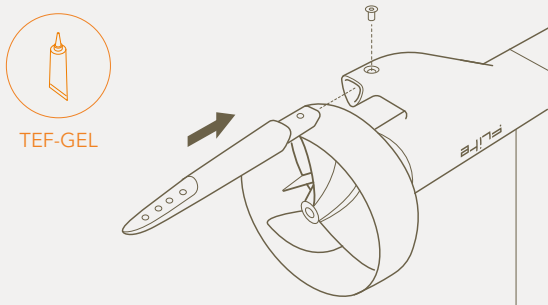

## Connect the wing

- 1 Remove your front wing from the travel bag and from its wing cover (if attached - depending on model).
- 2 Place the wing in position as shown. Ensure you have the correct fuselage cover to suit your wing (refer to page 16).
- 3 Insert the 3 fasteners taking care to ensure the correct set is being used for the particular wing model you are fitting (refer to page 16). ALWAYS add Tef-Gel to the fasteners first. The fasteners should extend by approximately 6-8mm through the wing when placed in the countersunk holes.
- 4 Tighten the fasteners with the supplied hex key, ensuring the fasteners are tight enough that the wing cannot move or wobble significantly during use. Use a torque of 6 Nm to tighten the fasteners.

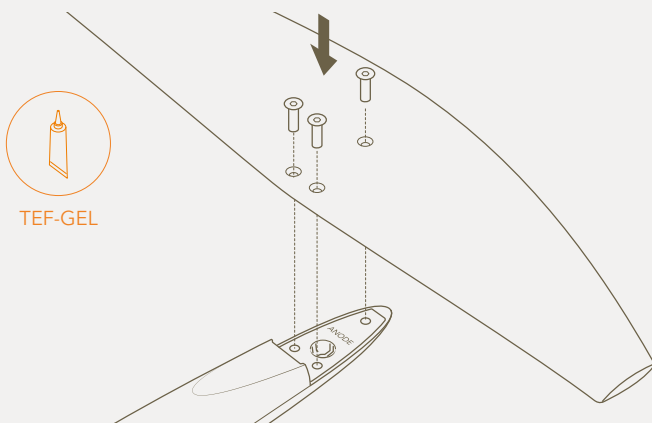

## Connect the stabiliser wing

- 1 Take the stabiliser wing from the travel bag and remove the wing cover.
- 2 Take the correct stabiliser wing shim from the accessories pouch and fit between the stabiliser wing and the fuselage tail.
- 3 To ensure correct mounting, direction and placement, the wing when installed correctly should have wing tips facing towards the underside of the board (the countersunk thread is an indication of this). The correct direction, is that of the rounded, curved leading edge facing the front wing.

ALWAYS ADD TEF-GEL TO THE STAINLESS STEEL FASTENERS THAT ARE BEING INSERTED INTO THE ALUMINIUM. IF LEAVING WINGS ATTACHED FOR EXTENDED PERIODS, ENSURE THAT YOU LOOSEN FASTENERS AND RE-APPLY TEF-GEL EVERY FEW WEEKS. FAILURE TO DO SO MAY RESULT IN CORROSION AND DAMAGE TO YOUR EFOIL FASTENER INSERTS.

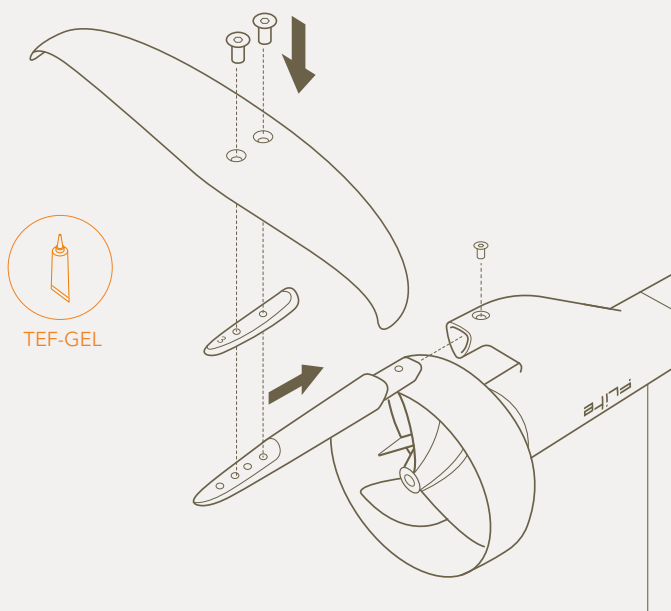

**PRO TIP** We have supplied 0, 1, 2, 3, 4 and 5 degree shims for you to experiment with to customise your ride. Which shim suits best depends on many aspects such as: preferred riding style, preferred riding speed, riding conditions, skill level and personal preference. Changing shims alters the amount of stabilising downforce provided by the tail, and also impacts the balance point of the foil and responsiveness. Beginners should start with 1 or 2 and adjust based upon preference. Lower shim numbers allow faster speeds without too much front foot pressure. Higher shim numbers create more stability and responsiveness, but lead to more lift at high speeds.

## Connect Flitecell to Fliteboard

With the eFoil, fuselage tail and wings attached, it's time to carefully turn your board over so it stands on BOTH the front wing and nose of the board.

- 1 Twist the lid latches and open the board lid.

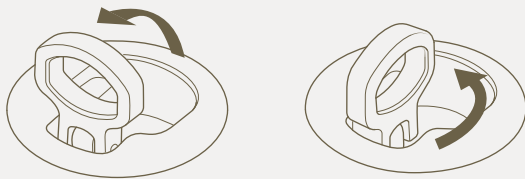

DO NOT OPEN LID WHILST IN THE WATER UNDER ANY CIRCUMSTANCES.

- 2 Take Flitecell by the handle and carefully lower it into the board cavity, ensuring to move cables out of the way first. The warning label should be facing up.

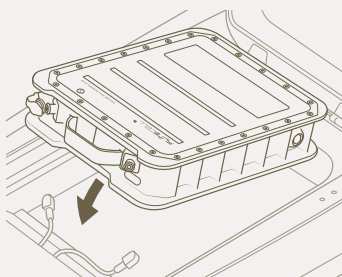

BE CAREFUL NOT TO DAMAGE THE BOARD SEAL WHEN FITTING FLITECELL. ANY KNICKS, CUTS OR DAMAGE TO THE SEAL MAY RESULT IN LEAKS.

BE CAREFUL NOT TO RECONNECT FLITECELL POWER CABLES WITHIN 10 SECONDS OF DISCONNECTION TO AVOID A POSSIBLE ARC.

- 3 If using a Flitecell Sport or Nano, place the spacer in the board cavity first.
- 4 Connect the orange power cable to the orange power in Flitecell. You will feel a secure click when properly engaged. **Note: Depress the button on the side of the connector when removing the connector.**
- 5 Connect the black power cable to the black power in Flitecell.

**Flitecell is now connected.**

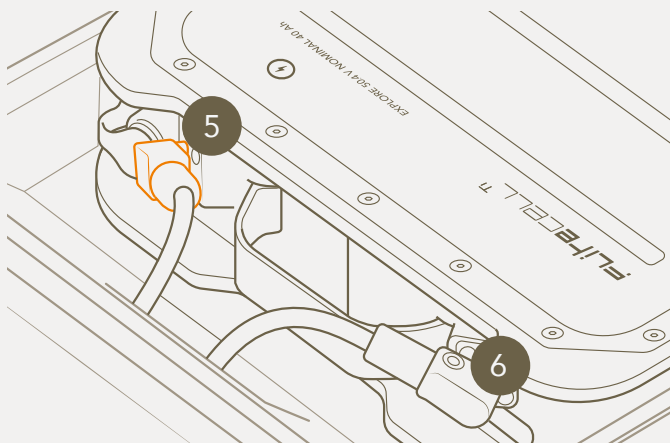

## Turning on Fliteboard

- 1 Make certain nothing is caught in the seal. Carefully close the lid.
- 2 Twist and lock the two lid latches.
- 3 A few seconds after the lid is shut in position, you will hear a **'beep beep beep'** which signifies that the Flitecell and board have automatically turned on.
- 4 If the external board light is not active, open the lid and ensure the power cables are properly connected, and there are lights on the Flitecell indicating it is switched on.
- 5 Flitecell will automatically turn off 10 seconds after the lid is opened.

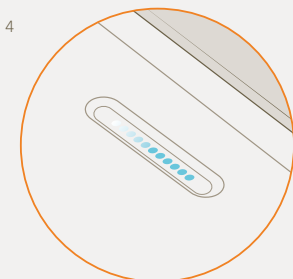
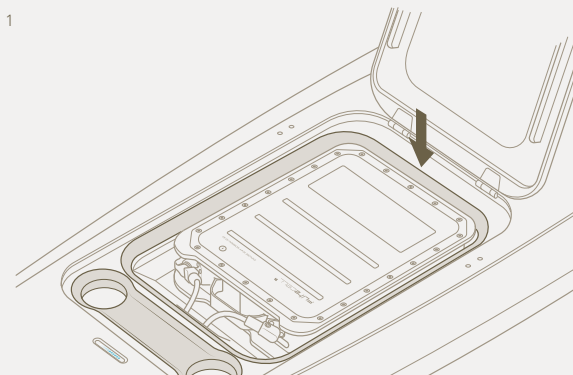

SEE PAGE 38 FOR PAIRING  
FLITE CONTROLLER

THE SEAL IS A CRITICAL COMPONENT. IF DAMAGED CONTACT YOUR FLITE AUTHORISED SERVICE PARTNER FOR A REPLACEMENT PART. NEVER RIDE THE BOARD WITH A DAMAGED SEAL.

THE FLITECELL AND CABLES ARE WATER RESISTANT; HOWEVER, ALWAYS KEEP FLITECELL, CABLES AND BOARD CAVITY DRY. WATER, ESPECIALLY SALT WATER, CAN ACCELERATE AGEING AND CORROSION. IF YOUR BOARD LEAKS, CHECK SEALS, AND CLEAN COMPONENTS CAREFULLY.

## Download Flite App and update



The Flite App is available to download in the Apple App Store and Google Play Store. We recommend using the Flite App to ensure your board and Flite Controller always have the latest software to deliver the best performance.

In addition to enhancing your experience on the water, Flite App connects you to a global community of Fliteboarders. Share your sessions, compete and discover new places to ride.



Download the  
Flite App

[fliteboard.com/app](https://fliteboard.com/app)



Watch our Flite App  
video at

[fliteboard.com/video](https://fliteboard.com/video)

## Connecting Flite App to Fliteboard

- 1 Turn off Flite Controller.
- 2 Ensure Fliteboard has power and the lid is closed.
- 3 Select **'Fliteboard'** from the **'Devices'** menu. When connected, the board Flitebox LED will turn purple. When performing some updates it will display green.
- 4 You will now be able to see the software version of the Fliteboard.
- 5 Once connected you can perform updates and sync session rides.
- 6 Connecting to Fliteboard will transfer settings from the app (eg knots and miles per hour).

WHEN NEW SOFTWARE UPDATES ARE AVAILABLE, YOU'LL SEE AN ORANGE UPDATE ICON.

BEFORE YOU UPDATE SOFTWARE MAKE SURE THE PHONE, FLITECELL AND FLITE CONTROLLER HAVE AT LEAST 20% CHARGE.

KEEP THE PHONE CLOSE AND IN LINE OF SIGHT WITH A STRONG WIFI/ CELLULAR NETWORK. DON'T USE THE PHONE FOR ANYTHING ELSE SUCH AS CALLS, TEXTS, OR OTHER APPS.

MAKE SURE THE FLITEBOARD LID REMAINS CLOSED DURING THE UPDATE PROCESS.

ENSURE FLITE CONTROLLER IS TURNED OFF AS THE APP CAN ONLY CONNECT TO ONE DEVICE AT A TIME.

## Connecting Flite App to Flite Controller

- 1 Turn off Fliteboard.
- 2 Ensure Flite Controller has power and is within range of the phone.
- 3 Select '**Flite Controller**' from the '**Devices**' list. When selected and connected, the current state of charge will be displayed.
- 4 You will now be able to see the software version of the Flite Controller and perform any updates here.

WHEN NEW SOFTWARE UPDATES ARE AVAILABLE, YOU'LL SEE AN ORANGE UPDATE ICON. WHEN UPDATING, DON'T USE THE PHONE FOR ANYTHING ELSE SUCH AS CALLS, TEXTS OR OTHER APPS.

## Capturing sessions

- 1 Fliteboard will automatically capture sessions to its onboard computer.
- 2 Connect to the Fliteboard and then tap '**Sync**' to view and download any new sessions.
- 3 Clicking a ride in the Sessions list will then take you to ride detail screen. Here you can play back your ride in various speeds, over an aerial map.



## Flite Controller overview

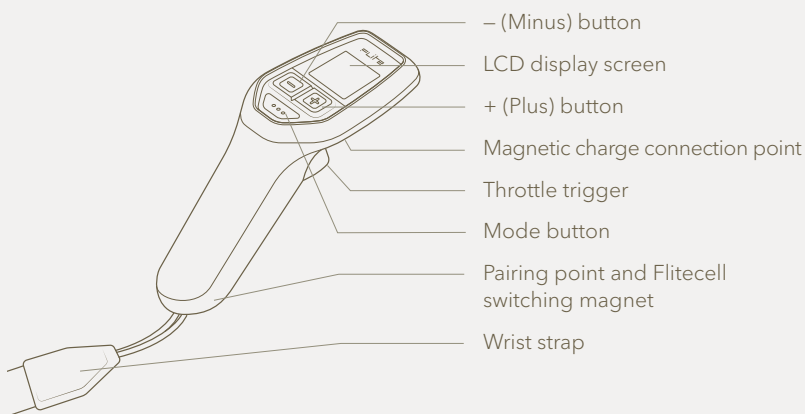

### Turn on and connect Flite Controller

- 1 Turn on Flite Controller by holding down the + button AND Mode (bottom) button together for 3 seconds.
- 2 After a 3 second press of both buttons, the Flite logo will appear with the software version number, and the Controller will move to the home screen with lock icon.

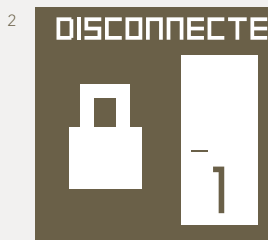
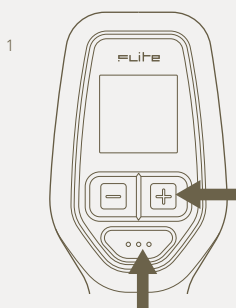

Flite Controller disconnected (requires pairing) and motor locked (requires arming). Gear 1.

Hold + button for 7 seconds to put into pairing mode.

IF THE LED STATUS LIGHT HAS A BLUE SOLID LIGHT (NOT BLINKING) YOUR FLITE CONTROLLER IS CONNECTED. IF THE FLITEBOX LIGHT IS FLASHING YOUR CONTROLLER AND FLITEBOARD NEED TO BE PAIRED.

## Flite Controller screen guide

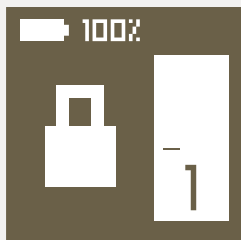

### Motor locked

Ready to arm.  
Flitecell 100% charged  
Gear set to 1

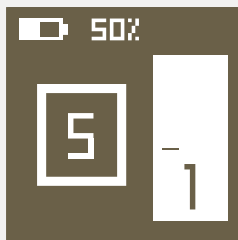

### Motor armed

Motor unlocked with 5 seconds  
to squeeze the throttle trigger.  
Flitecell charge 50%

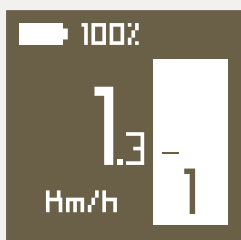

### Current Speed / Gear

Speed 1.3km/h  
Gear 1



### Distance

Travelled 6.4kms  
Remaining 24.7kms  
Current Speed 23.6km/h



### Time

Elapsed 60mins  
Remaining 12mins  
Current speed 23.6km/h



### Speed

Maximum 35.1km/h  
Average 13.2km/h  
Current speed 23.6km/h

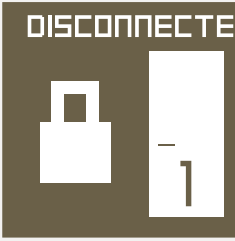

### Disconnected (scrolling)

Flite Controller is not connected or under water. Hold plus for 7 seconds until Flite Controller displays LOOKING FOR NEW PAIR.

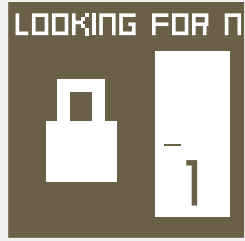

### Looking for new pair (scrolling)

Flite Controller is looking for a new pair.

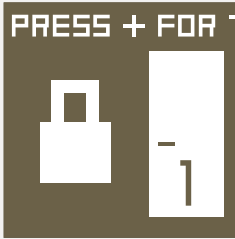

### Pairing required

Flite Controller is not paired. Hold plus for 7 seconds until Flite Controller displays LOOKING FOR NEW PAIR.

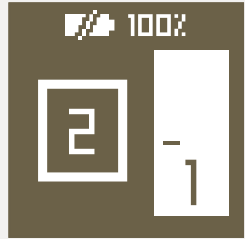

### Battery not paired

Repeat pairing process (see page 38).



### Diagnostics

Flitecell kilowatts 1.5  
 RPM x 1000 = 2,100  
 ESC Temp 40 Degrees  
 Flitecell Temp 40 Degrees  
 Flitecell Charge 100%  
 Current Speed 23.6km/h



### Efficiency

60 Wh/km  
 Flitecell charge 100%  
 Current speed 23.6km/h

## Flite Controller screen guide



### Charge remaining

Flitecell 98%  
Flite Controller 66%

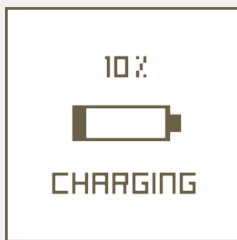

### Flite Controller charging

Flite Controller currently  
at 10% state of charge.



### 50% Flitecell warning

Flitecell has 50% (or less)  
remaining charge.



### Fliteboard tilted

Fliteboard is disabled  
due to the tilt angle.



### High Current

Motor Cool Down mode  
will be activated if power  
isn't reduced.

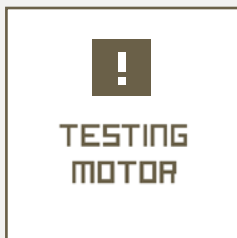

### Testing Motor

To avoid accidental injury,  
this feature prevents  
the motor from being  
turned on fully and any  
overheating to seals, when  
the board is on land.

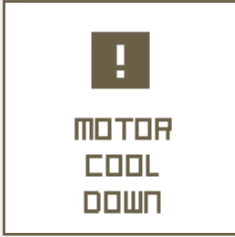

#### **Motor Cool Down**

The motor needs to cool down. Fliteboard is limited to low gears for 1 minute to allow motor to cool.



#### **High Temp**

Flitecell is too hot. Ride using low power to allow Flitecell to cool, otherwise Flitecell may shut down.



#### **Flitecell charge critical**

Flitecell charge very low, immediately return to shore. Fliteboard is limited to low gears only to conserve charge.



#### **Flite Controller low charge**

Flite Controller requires charge. Ensure Flite Controller is charged above 50% each ride.

CONNECTING TO FLITEBOARD WILL TRANSFER SETTINGS FROM THE APP (EG KNOTS AND MILES PER HOUR).

PLEASE BE AWARE THAT SPEED READOUT AND WAVE MODE REQUIRES A GPS CONNECTION. IF YOU ARE RIDING WITH POOR GPS SIGNAL YOU MAY NOT BE ABLE TO SEE THE SPEED YOU ARE TRAVELLING AT OR USE WAVE MODE.

## Follow this pairing procedure before Fliteboarding

- 1 Connect Flitebox power cables to Flitecell. Close the lid and wait for the audible beep indicating the board is switched on.
- 2 Open the Fliteboard lid and place the base of the Flite Controller on the pairing target of the Flitebox (between the Flitecell cables).  
Note: With the lid open, the system will shut down after 10 seconds.
- 3 Once the LED lights change to scrolling orange, remove the Flite Controller from the pairing target and close the lid.
- 4 Set the controller into pairing mode by holding the + button for 7 seconds until the words '**PRESS MODE TO COMMENCE PAIRING**' appear. Then press mode button to confirm. The words '**LOOKING FOR NEW PAIR**' will appear.
- 5 Once paired successfully, the LEDs will change to a light blue colour.
- 6 Fasten the latches once paired successfully.

Troubleshooting: If the lights are not solid blue, or the battery icon on your Flite Controller is crossed out, this indicates that the Flitecell has not paired, and the process needs to be repeated from Step 1.

The Magnetic Clip can be used to keep Flitecell activated longer than 10 seconds. Remove once paired.

DO NOT HOLD THE FLITE CONTROLLER IN THE PAIRING POSITION FOR MORE THAN 30 SECONDS. HOLDING THE FLITE CONTROLLER IN THIS POSITION WILL PUT THE BOARD INTO SOFTWARE UPDATE.

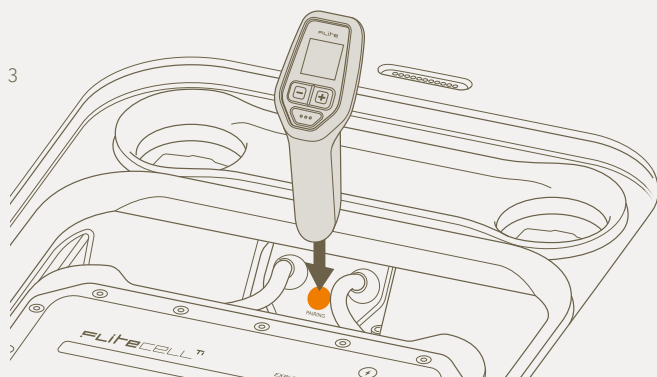
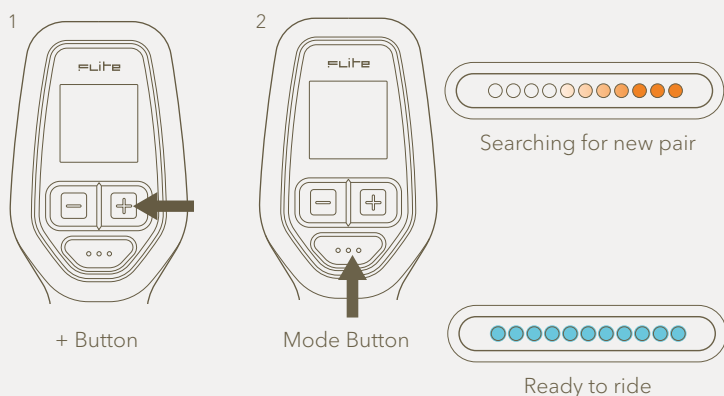

## Flitebox light

## Flite Controller meaning

---

	Light blue solid	Ready to ride
	Red flashing	Alert (high temp, tilt, overcurrent, system error)
	Blue flashing	Armed
	Blue chasing	Motor running
	Orange flashing	Disconnected Flitecell / Controller
	Orange chasing	Searching for new pair Flitecell / Controller
	Purple solid	Flite App connected
	Purple chasing	Flite App data transfer

---

## Arming the motor

Fliteboard uses a safety lock to guarantee that riders cannot accidentally spin the motor by bumping the throttle trigger unintentionally. Riders must arm (unlock) the motor to Fliteboard.

- 1 To arm the motor, pull the throttle all the way in on the Flite Controller and then release it completely.
- 2 Press and then release the minus button.
- 3 Pull the throttle trigger within 5 second countdown window to activate the Flite Propeller or Flite Jet. Always verify the eFoil is clear and in a safe location before activating the motor.

**IMPORTANT: NEVER RUN THE MOTOR OUT OF WATER FOR MORE THAN 3 SECONDS, AS DOING SO CAN OVERHEAT AND DAMAGE THE SHAFT AND SEALS.**

1

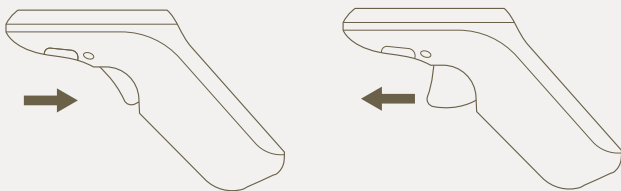

2

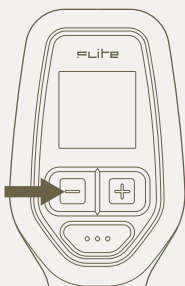

3

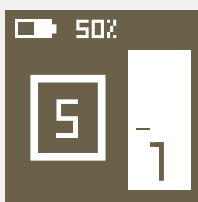

Countdown window appears. Pull the throttle trigger completely to activate the Flite Propeller or Flite Jet.



## Get Fliteboarding

Fliteboard recommends that first time riders have at least one lesson with a certified Fliteschool. To find your nearest Fliteschool visit [fliteboard.com/locations](https://fliteboard.com/locations)

### Select a suitable riding location

A location with deep enough water is essential. The wings and eFoil should never make contact with anything below the surface, including a sand bottom. Be aware of tide times, as well as submerged items such as branches, coral, boat chains and fishing lines. If you are unsure about the local area ask someone who knows the waterway for advice. Be aware the board can be submerged with rider weight, increasing the required clearance.

Choose a location away from swimmers and other water users and ensure local laws allow motorised craft to be used in the area.

Learning to Fliteboard in very smooth water without waves or strong currents is SIGNIFICANTLY easier and safer than learning in choppy water. Your first Fliteboard experience will be challenging (but rewarding) so choose a location and weather conditions that allow for the easiest possible learning experience.

Ride time and range are dependent upon:

- Rider weight
- Average speed
- Wing choice
- Water / wind conditions

ENSURING SAFE WATER DEPTH IS EXTREMELY IMPORTANT BEFORE RIDING. SELECT A LOCATION THAT HAS A MINIMUM DEPTH OF AT LEAST 1.5 METRES.

ALWAYS MONITOR FLITECELL LEVELS WHILE RIDING AND TAKE CARE NOT TO DEplete THE FLITECELL BEFORE RETURNING TO YOUR POINT OF ORIGIN.

NEVER RIDE FLITEBOARD FURTHER FROM SHORE THAN YOU ARE PREPARED TO SWIM BACK.

## Engage the motor and get moving

- 1 Climb onto the board, taking care not to kick the hydrofoil wings or mast.
- 2 Lie on the board, positioned so that you can touch the front of the Fliteboard with your hand (or the front handle if using the Fliteboard AIR).
- 3 Verify Flite Controller is set so you can see gear 1 displayed on the lock screen. This is your starting gear setting once armed (it can be changed later if you are an advanced rider).
- 4 Arm the motor and squeeze the gear 1 throttle trigger. The board should start to move. You should be on power level 1 (a low gear setting).
- 5 Practice riding lying on the board and changing speed using the buttons between gear 1 and gear 3. Be sure to keep enough weight on the front of the board to keep the nose of the board down and parallel to the water.

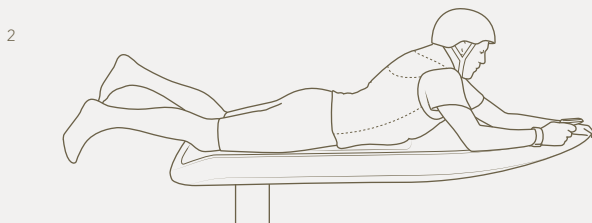
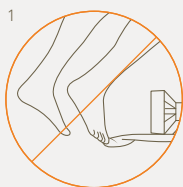

**PRO TIP** Fliteboard has been designed with a cruise control system in mind. Squeezing the trigger all the way in makes it easier to use your thumb to change the speed (from level 1 to 20). As you accelerate you may need to shuffle forward to keep the nose down.

## Getting to your knees

- 1 Once comfortable lying on the board, arming the motor, changing speed and riding the board lying down, it's time to get to your knees.
- 2 Depending on your weight, board and conditions, you may wish to move to your knees on gear 3, 4, 5 or 6. You want to be travelling fast enough that you won't nose dive or sink, but not so fast that you are bouncing over chop, planing quickly or starting to foil. A speed of 6 - 8 km/h on the GPS display on the Flite Controller is a good speed for getting to your knees.
- 3 Place both hands on the board, smoothly push your body up and slide both knees under you onto the board. Your knees should be positioned just in front of the lid hinges. Be careful not to put your knees on the hinges themselves.
- 4 Keep your body weight forward to keep the nose down and to prevent the eFoil from coming up too high.

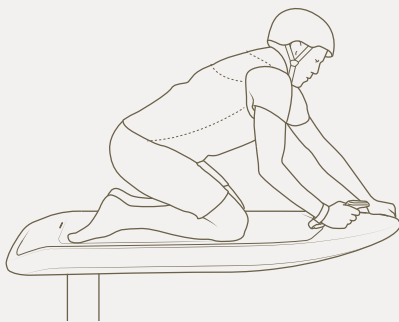

2

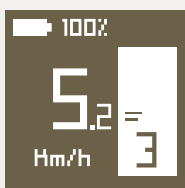

**PRO TIP** Be careful not to let go of the throttle trigger as you move to your knees. You should practice maintaining a constant speed when changing body positions on the board.

Once you feel ready, you can practice starting to foil on your knees by carefully moving your head and upper body back. As soon as you hear the noise change from the board leaving the water, shift your weight forward again to level off or touch down.

## Standing up

Check that you have clear flat water in front of you with no obstacles or other vessels.

Select a speed where the board feels stable. The ideal speed depends on your weight and board choice, but between 8 - 12 km/h is a good speed for standing up.

- 1 While being careful not to let go of the throttle trigger (so you maintain a constant speed) place your front foot in the space in front of your knees. Your toes should be near the front of the foot pad and slightly to one side. (Refer to the diagram in the below PRO TIP)



- 2 Take a moment to get your balance. Then, stand up, with as much weight as possible pushing through your front foot. This should feel like standing from a lunge position. Keeping your weight on your front foot keeps the board and nose down, which in turn keeps the foil in the water. Standing up with weight on your rear foot can result in the foil engaging and then an unintended crash.
- 3 Once standing keep your weight forward over your front knee. Your chest and nose should be lined up with, or in front of your front knee.

**PRO TIP** The ideal body position is with your body twisted forward, with front foot just behind the front of the deck grip, and rear foot 10cm in front of the latches, with both feet hip width apart. This stance is similar to the 'Warrior One' Yoga stance. This riding stance keeps your weight forward allowing good control over the pitching of the board forward, aft, left and right.

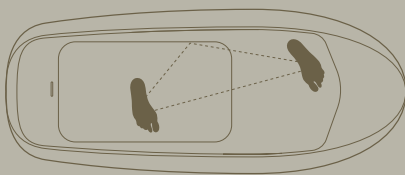

- 4 Once standing, practice slowly adding speed, but always while pushing down hard through your front leg. The wing, motor and your own bow wave will want to push the nose up. Push down hard and practice accelerating to planing speed, with the board flat on the water. Taking your weight off your front foot will increase the lift of the wing, and thus engage the foil, and likely result in a crash until you have learned to balance the board on all axes whilst foiling.

## Fliteboarding for the first time

Like learning to ride a bike for the first time, learning to Fliteboard is challenging as it requires your brain to learn a new way to balance. There is also potential for you to fall on the wings if not careful. Wear appropriate safety equipment including a helmet and Impact Vest / PFD, take your time and follow these steps.

Once comfortable standing at medium speeds, practice going faster with as much weight as possible over your front foot. Unlike surfing, you control the board more with your front foot. Weight on your front foot with your body leaning forward is safe, as it keeps the wing and motor submerged in the water. Whenever you become uncomfortable, lean forward toward the nose of the board. This will ensure the board is on the water and stable.

- 1 Practice standing in the rider's stance and gradually increase your speed. The initial goal is to be able to ride at safe foiling speed (so you are in control and still within local laws) with the board still on the water. You do this by keeping your weight forward.
- 2 While planing at the correct speed with your feet in the correct position and the board LEVEL on the water; very gradually start to transfer weight backwards. You will feel slightly less pressure on your front foot and more pressure on the back foot. Do this carefully, with your weight over the centre line of the board and your core engaged.
- 3 As soon as you feel the board leave the water, you are foiling. Lean forward again and touch down. The goal is to foil as LOW as possible for very short sections. Foiling for 5 metres at a time and then touching down again is all you need to do.
- 4 Practice this and your brain will work out the rest. Before long you will be foiling for longer periods and then continuously.

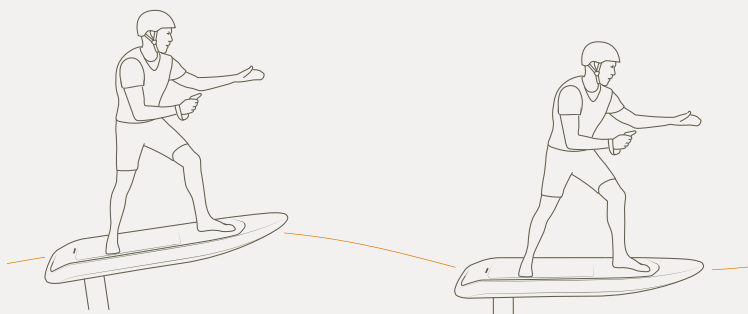

Don't go too high

More pressure on front foot

**PRO TIP** The safest and easiest way to learn to Fliteboard is to foil low and practice repeated touch and go's. As you foil higher you expose yourself to the risk of a crash where you could hit the wings. You may lose your confidence and learning will take longer.

## Fliteboarding pro tips

If you shift your weight too far to one side, it is not possible to recover. Jump away from the board in the direction you are falling. This takes you SAFELY away from the eFoil.

Keep your weight forward and press down through your front knee. Confirm your feet are in the correct position.

Don't vary your speed too quickly, it may unsettle the foil and make balance more difficult. Like an aeroplane, the eFoil wings need a constant speed for smooth flying.

Don't try to foil going too slow. The wings will stall and you may crash.

Don't try to turn whilst foiling until you are very comfortable in a straight line.

Keep the board flat and level.

If you are a light rider, use the settings menu on the Flight Controller to select low power mode.

If you are a heavier rider, select a higher gear before arming the board. This sets the default gear for the next time you arm.

If you are a pro rider, select a high gear before arming and modulate the throttle trigger to control your speed.

## Foiling through turns

Turning while foiling requires careful balance on all axes.

Start by doing very wide turns.

As you gain experience you can try tighter turns.

Keep speed constant.

In tight turns you will need to apply more force to your back leg to maintain foil altitude.

All of this might sound complex, but if you keep your weight forward, practice in flat water, maintain constant speed, and take learning step by step, you will likely be foiling in no time.

**ALWAYS ENSURE THE FLITE CONTROLLER LANYARD IS ADJUSTED AND SECURELY ATTACHED TO YOUR WRIST BEFORE FLITEBOARDING.**

**RAPID RELEASE OF THE TRIGGER CAN CAUSE THE NOSE OF THE BOARD TO SUDDENLY DROP AND MAY CAUSE A CRASH.**

**ALWAYS TEST THE TRIGGER RESPONSIVENESS AT THE START OF YOUR FLITEBOARDING SESSION TO ENSURE IT IS FUNCTIONING CORRECTLY.**

## Maintenance and storage

READ THROUGH THE ENTIRE STORAGE AND MAINTENANCE INSTRUCTIONS BEFORE STORING YOUR BOARD.

- 1 It is essential that your Fliteboard be serviced as per the 'Maintenance schedule' at the end of this User Guide to retain its high level of performance, safety and reliability, including warranty, as mentioned previously.
- 2 The service intervals are in both hours of ride time or years, whichever comes first.
- 3 The service schedule and intervals assume you will use your Fliteboard in accordance with our guidelines.

## Periodic checks

- 1 Ensure that you view our 'Care and Maintenance video' [fliteboard.com/video](http://fliteboard.com/video) before first using your Fliteboard.
- 2 Ensure that after each session, you visually inspect all elements of your Fliteboard including board, wings, mast, Flitecell and Flite Controller for any damage or water ingress.
- 3 Ensure that you perform the 6 Month Flitecell Checklist located on the Support Page on the website.
- 4 Ensure all connections are clean, free from corrosion and damage after each use.
- 5 Ensure the hinges have been rinsed with fresh water, are clean, free from corrosion and damage after each use.

## Maintenance schedule intervals

The hours / years intervals shown in the maintenance schedule section of the User Guide are intended as a guide. If you operate a Fliteschool then supplementary servicing may be necessary.

**CAUTION:** Avoid leaving your Fliteboard tied up in marinas or near vessels for extended periods of time. Any earth leakage from surrounding vessels can lead to accelerated corrosion of your eFoil components.

Please contact [support@fliteboard.com](mailto:support@fliteboard.com) for any queries or questions.

## **Fliteboard, PRO, ULTRA / L**

### **Post ride**

Open the board lid slowly, taking care to not let it fall on the nose of the board. If the lid is opened too far it may fall and damage the nose of the board.

After each ride, check to see if any water has leaked into the Flitecell cavity.

If so, check the cause of the leak which may include: sand present on the sealing surface; a damaged or dislocated seal; damaged hinges or latches; or something obstructing the lid when closed.

Once the Flitecell has been removed ensure that the complete board, including Flitecell compartment, seals, hinges, lid and eFoil are washed thoroughly in fresh water.

Let the board air dry and then wipe down with a clean, dry absorbent cloth. Ensure that Contact Cleaner is sprayed onto all electrical connections.

### **Regular maintenance**

Check the board regularly for damage or cracks. If damage is present have it repaired by a professional surfboard or sailboard repairer.

Inspect the orange mast flange seal regularly for any damage and ensure it is kept clean and free of any sand, grit or dirt.

During daily use ensure that the eFoil is removed from the board and wings from the eFoil at least every three days. Ensure Contact Cleaner is applied to all electrical connection points and Tef-Gel is reapplied to all screws.

### **Storage**

Ensure that all sand, grit, dirt, and salt residue has been washed off with fresh water, and sufficiently dried. Ensure that the Flitecell has been wiped down with a clean, dry absorbent cloth while switched off.

Ensure the board and deck grip are dry before storage.

Apply Contact Cleaner to all connectors to reduce the risk of corrosion.

Take care not to scratch the board and wings.

Place your Fliteboard in the provided bag, then store in a clean and dry environment.

Keep the board and bag out of the sun.



## **Fliteboard AIR**

### **Post ride**

Wash the inflatable bladder with warm soapy water and dry before storage.

The inflatable bladder can remain inflated, or be deflated and stored on or off the carbon insert to suit your storage preference.

### **Regular maintenance**

The inflatable bladder can be repaired using the supplied repair kit. 15 - 16 PSI is the recommended inflation pressure.

## **eFoil system**

### **Post ride**

Disconnect the Flitecell power cables.

Rinse thoroughly with clean fresh water after every use.

Rinse the inside of the mast (through the notch in the rear of the flange) with fresh water.

Rinse around the mast flange to wash salt away from the board connection area (if keeping the board and eFoil attached).

### **Regular maintenance**

Disassemble the eFoil from the board.

Remove the wing, fuselage cover and tail, and clean thoroughly with fresh soapy water to remove any built-up salt or sand.

### **Storage**

Always store the eFoil in a clean, dry environment.

## **Flite Controller**

### **Post ride**

Rinse the Flite Controller in fresh water to clean away salt and debris. Ensure a steady stream of fresh water is applied directly into the trigger housing. While doing so press and de-press the trigger numerous times to loosen any sand, grit, debris that may affect its performance.

Peel out the rubber cover on the underside and clean this with fresh water. Ensure this area is dry before replacing the cover.

### **Regular maintenance**

Pre and post season, the 3 torque screws on the underside of the controller can be undone to release the trigger. This will allow you to thoroughly clean and inspect the trigger, spring and magnet.

### **Storage**

Store in a cool dry place, out of the sun.

## Flitecell

### Post ride

Wipe Flitecell down with a wet cloth (freshwater), and clean Flitecell contacts and data connector with Contact Cleaner.

Flitecell is waterproof but it should remain dry where possible. DO NOT submerge or shower.

Avoid placing Flitecell on the sand, which can make its way into the Flitecell cavity and scratch surfaces.

DO NOT charge the Flitecell immediately after use. The Flitecell temperature may be too high. Allow 30 mins between riding and charging to allow for cooling.

DO NOT clean the Flitecell or charger with denatured alcohol or other flammable solvents.

IF THE BOARD HAS LEAKED AND / OR THE FLITECELL HAS BEEN SUBMERGED IN WATER, INSPECT FOR WATER INGRESS USING THE SIGHT GLASS LOCATED ON THE SIDE OF THE FLITECELL. STAND THE FLITECELL UP ON ITS BOTTOM END FOR ONE MINUTE AND THEN PLACE THE FLITECELL ON ITS SIDE WITH THE SIGHT GLASS FACING DOWN FOR ONE MINUTE. INSIDE THE SIGHT GLASS IS A COLOUR CHANGING LABEL WHICH WILL TURN RED IF WATER IS PRESENT. INSPECT THE SIGHT GLASS AND CONFIRM THAT WATER IS NOT PRESENT BEFORE CHARGING AND USING A FLITECELL THAT HAS BEEN IMMERSSED IN WATER.

IF A FLITECELL HAS BEEN DROPPED OR DAMAGED, CONTACT FLITEBOARD IMMEDIATELY AND DO NOT USE THE FLITECELL.

### Regular maintenance

Examine the charger regularly for damage to the cord, plug, enclosure or other parts.

### Storage

Keep Flitecell stored out of the reach of children and pets.

DO NOT store the Flitecell near heat sources such as a furnace or heater. DO NOT leave the Flitecell inside of a vehicle on hot days. The ideal storage temperature is 10°C - 25°C.

Do NOT store the Flitecell whilst charging. Disconnect the charger when not in use.

DO NOT store the Flitecell fully charged or discharged for a longer period of time.

For long or short term storage a charge state of 40% (1 LED ON indicates 25 - 35% charge) is optimal. Only fully charge the Flitecell when planning a ride. We recommend that you discharge the Flitecell during your final session of the season and charge back up to the above state.

## Troubleshooting

Issue	Troubleshooting guide
<b>Fliteboard starts to slow or 'limp'</b>	This is a sign your Flitecell is about to run down or over heat. Move out of the water and recharge your Flitecell. Refer to the Flitecell charging instructions (page 20).
<b>Fliteboard turns off while riding</b>	Move out of the water to a safe, dry, clean area. Check the LED on Flitecell to confirm if it still has charge. If it has charge, disconnect and reconnect the Flitecell to see if you can establish a connection. Inspect the Flitecell for water or damage. There should be no water inside the Flitecell housing.
<b>Flite Controller disconnects</b>	Re-arm the Flite Controller. See arming instructions (page 40).
<b>Flite Controller unpairs</b>	Re-pair the Flite Controller. See pairing instructions (page 38).
<b>Flitecell charger won't connect</b>	Disconnect and reconnect. Contact Fliteboard Customer Support. <a href="http://fliteboard.com/support">fliteboard.com/support</a>
<b>Flite Controller won't turn on</b>	Ensure Flite Controller is fully charged. See Flite Controller charging instructions (page 19).
<b>Flite Controller shows a battery or temperature warning</b>	Slow down or decrease power consumption to cool the Flitecell down. The Flite Controller will warn you when the Flitecell temperature reaches 55°C and again at 60°C. At 65°C the Flitecell will automatically start to shut down to preserve itself.

## Issue

## Troubleshooting guide

---

### Water in the Fliteboard cavity

Remove the board from the water.  
Remove the Flitecell. Dry the board completely.  
Check the Flitecell for leaks. If the Flitecell has taken in water refer to the section below.  
Once dried and re-assembled, take care that the Fliteboard cavity seal is properly compressed when closing the Fliteboard lid.

---

### Water in Flitecell

Flitecell has an indicator for water damage. If water has penetrated the casing, regularly check the circular water indicator on the side of your Flitecell. If the sticker has turned red, this means water has penetrated the housing.

IF WATER HAS PENETRATED THE FLITECELL, PLEASE SET FLITECELL ASIDE IN A COOL DRY PLACE. DO NOT ATTEMPT TO USE A FLITECELL THAT HAS BEEN WATERLOGGED. CONTACT FLITEBOARD IMMEDIATELY.

---

### Unable to pair Flite Controller

Please ensure no other controllers or boards are switched on. Try again as per pairing instructions (page 38).

---

### Unable to pair Flite Controllers to multiple boards

Do not attempt to pair multiple Flite Controllers to multiple Fliteboards simultaneously. Always pair one at a time.

---

### Reduced ride time

The battery management system (BMS) balances and optimises the Flitecell during each charge cycle. Allow 24 - 48 hours after charging before Flitecell use.

---

## Technical Specifications

Load range	RECOMMENDED	WARRANTY LIMIT
AIR / Fliteboard Prop	120kg / 265lbs	120kg / 265lbs
AIR / Fliteboard Jet	100kg / 220lbs	120kg / 265lbs
PRO Prop	100kg / 220lbs	120kg / 265lbs
PRO Jet	100kg / 220lbs	120kg / 265lbs
ULTRA / L Prop	90kg / 200lbs	100kg / 220lbs
ULTRA / L Jet	80kg / 175lbs	100kg / 220lbs

**Ride time 85kg rider** Up to 1 hr 30 min (Flitecell Explore)  
Using a large wing at slow foiling speed, it's possible to ride for over 2 hours.

Board details	KG	LBS	MEASUREMENTS	L
Fliteboard ULTRA L	8	17.6	1299 L x 580 W x 110mm D (4'2" x 22 53/64" x 4 21/64")	57
Fliteboard ULTRA	9	19.8	1299 L x 580 W x 110mm D (4'2" x 22 53/64" x 4 21/64")	57
Fliteboard PRO	9.3	21	1524 L x 624 W x 109mm D (5'0" x 24 9/16" x 4 9/16")	67
Fliteboard	11.9	26	1735 L x 714 W x 118mm D (5'8" x 28 7/64" x 4 41/64")	100
Fliteboard PRO Fibreglass	10	22	1524 L x 624 W x 109mm D (5'0" x 24 9/16" x 4 9/16")	67
Fliteboard Fibreglass	12.8	28	1735 L x 714 W x 118mm D (5'8" x 28 7/64" x 4 41/64")	100
Fliteboard AIR	12.6	28	1833 L x 764 W x 132mm D (6'0" x 30 5/64" x 5 13/64")	164

## Fliteboard, PRO and ULTRA / L

**Materials** Carbon fibre, Innegra, fibreglass, aircraft grade aluminium, high quality wood laminates and composites.

### Fliteboard AIR materials

<b>Type</b>	Inflatable
<b>Materials</b>	Selytech Composite Super Light Drop Stitch Fabric / PVC / EVA
<b>Pressure</b>	15 - 16 PSI

### Travel case

<b>Fliteboard ULTRA / L</b>	1390 x 670 x 170mm (4'5" x 2'3" x 6' 3/8")
<b>Fliteboard PRO</b>	1630 x 700 x 170mm (5'3" x 2'3" x 6' 3/8")
<b>Fliteboard</b>	1800 x 760 x 170mm (6' x 2'5" x 6' 3/8")
<b>Fliteboard AIR</b>	1220 x 600 x 300mm (7'2" x 2' x 12")
<b>eFoil case</b>	1100 x 640 x 260mm (3'8" x 2'2" x 10")
<b>Flitecell travel bag</b>	450 x 370 x 90mm (5'3" x 2'3" x 3' 5/8")

## Flite eFoil system

Input power	5,000 Watts
Max output power at shaft	3,600 Watts
Nominal voltage	52V
Maximum current	100A
Motor type	Brushless
Motor speed	4500 rpm peak
Protections	Overheating, overcurrent
Flite Propeller diameter	142mm
Flite Propeller guard diameter	155mm
Flite Jet diameter	90mm

## Flite Controller

Communication type	Bluetooth
Speed control	20 virtual gears
Runtime	Average charge 24 hrs / Standby 200 hrs
Rated cycles	1000 charge cycles
Protection grade	IP67

## Flitecell Fast Charger

Charging current	25A
Charge time	1hr 45min Flitecell Explore 1hr 15min Flitecell Sport 50 min Flitecell Nano

## Flitecell Charger

Charging current	13.5A
Charge time	2hr 30min Flitecell Explore 1hr 45min Flitecell Sport 1hr Flitecell Nano

## Flitecell Explore

<b>Size</b>	390mm x 305mm x 80mm (15" x 12" x 13")
<b>Capacity</b>	40Ah / 2016Wh
<b>Weight</b>	14.5kg / 32lbs
<b>Protection</b>	IP67
<b>Max charge voltage</b>	58.8V
<b>Min voltage</b>	42V
<b>Nominal voltage</b>	50.4V
<b>Rated continuous discharge current</b>	100A
<b>Rated charge current</b>	25A
<b>Rated cycles &gt;80% capacity</b>	400 Cycles
<b>Temperature discharge limits</b>	0 - 70 Degrees C 32 - 158 Degrees F
<b>Temperature charge limits</b>	0 - 50 Degrees C 32 - 122 Degrees F
<b>Communication</b>	Bluetooth Low Energy
<b>BMS critical functions</b>	Balancing, Over-temperature (Charge / Discharge) Over-current, short-circuit protection, reverse polarity and over & under voltage.
<b>Other safety</b>	3 levels of fusing adds redundancy if BMS failure occurs. Conformal / resin coatings used on PCB's.  Phase Changing Material between cells and sight glass to check for leaks.



## Flitecell Sport

<b>Size</b>	305mm x 305mm x 80mm (12" x 12" x 13")
<b>Capacity</b>	29.4Ah / 1487Wh
<b>Weight</b>	10.6kg / 23.4lbs
<b>Protection</b>	IP67
<b>Max charge voltage</b>	58.8V
<b>Min voltage</b>	42V
<b>Nominal voltage</b>	50.4V
<b>Rated continuous discharge current</b>	100A
<b>Rated charge current</b>	25A
<b>Rated cycles &gt;80% capacity</b>	400 Cycles
<b>Temperature discharge limits</b>	0 - 70 Degrees C 32 - 158 Degrees F
<b>Temperature charge limits</b>	0 - 50 Degrees C 32 - 122 Degrees F
<b>Communication</b>	Bluetooth Low Energy
<b>BMS critical functions</b>	Balancing, Over-temperature (Charge/Discharge) Over-current, short-circuit protection, reverse polarity and over & under voltage.
<b>Other safety</b>	3 levels of fusing adds redundancy if BMS failure occurs. Conformal / Resin coatings used on PCB's.  Phase Changing Material between cells and sight glass to check for leaks.

## Flitecell Nano

<b>Size</b>	218mm x 305mm x 80mm (8.6" x 12" x 13")
<b>Capacity</b>	16.8Ah / 806Wh
<b>Weight</b>	6.2kg / 13.7lbs
<b>Protection</b>	IP67
<b>Max charge voltage</b>	58.8V
<b>Min voltage</b>	42V
<b>Nominal voltage</b>	50.4V
<b>Rated continuous discharge current</b>	100A
<b>Rated charge current</b>	25A
<b>Rated cycles &gt;80% capacity</b>	400 Cycles
<b>Temperature discharge limits</b>	0 - 70 Degrees C 32 - 158 Degrees F
<b>Temperature charge limits</b>	0 - 50 Degrees C 32 - 122 Degrees F
<b>Communication</b>	Bluetooth Low Energy
<b>BMS critical functions</b>	Balancing, Over-temperature (Charge/Discharge) Over-current, short-circuit protection, reverse polarity and over & under voltage.
<b>Other safety</b>	3 levels of fusing adds redundancy if BMS failure occurs. Conformal / Resin coatings used on PCB's.  Phase Changing Material between cells and sight glass to check for leaks.

## **Shipping and transport**

Flitecell (batteries) are considered a dangerous good and must not be shipped without working with a dangerous goods shipping specialist.

Shipping batteries marked as normal goods without informing the shipping party is illegal and dangerous. The Material Safety Data Sheet (MSDS) is required for shipping the batteries.

## Warranty registration / Details of purchase

Customer name

---

Business name  
(if applicable)

---

Country & State

---

Purchased from

---

Date of purchase

---

Board type & serial number

---

eFoil type  80cm  75cm  60cm

---

Propulsion  Flite Propeller  True Glide  Flite Jet

---

Flitecell type  Explore  Sport  Nano

---

eFoil serial number

---

Flitecell serial number(s)

---

Flite Controller serial number(s)

---

Flitecell Charger type & serial number

---

## Maintenance schedule

### FIRST 100 HOURS / 1 YEAR SERVICE

#### Inspected

Mast

Fuselage

Flitebox

Cables

Propeller Guard

Propeller

Jet

Flitecell Health

#### Replaced

Seals

Oil

Flitebox Gore vent

Cables

Propeller Guard

Propeller

Jet

Anode

Other

#### Comments

eFoil Hours of use

Date

Name of Technician

Signature of Technician

Authorised Service Partner

## Maintenance schedule

### 200 HOURS / 2 YEAR SERVICE

WHICHEVER COMES FIRST

#### Inspected

Mast

Fuselage

Flitebox

Cables

Propeller Guard

Propeller

Jet

Flitecell Health

#### Replaced

Seals

Oil

Flitebox Gore vent

Cables

Propeller Guard

Propeller

Jet

Anode

Other

#### Comments

eFoil Hours of use

Date

Name of Technician

Signature of Technician

Authorised Service Partner

## Maintenance schedule

### 300 HOURS / 3 YEAR SERVICE

WHICHEVER COMES FIRST

#### Inspected

Mast

Fuselage

Flitebox

Cables

Propeller Guard

Propeller

Jet

Flitecell Health

#### Replaced

Seals

Oil

Flitebox Gore vent

Cables

Propeller Guard

Propeller

Jet

Anode

Other

#### Comments

eFoil Hours of use

Date

Name of Technician

Signature of Technician

Authorised Service Partner

## Maintenance schedule

### 400 HOURS / 4 YEAR SERVICE

WHICHEVER COMES FIRST

#### Inspected

Mast

Fuselage

Flitebox

Cables

Propeller Guard

Propeller

Jet

Flitecell Health

#### Replaced

Seals

Oil

Flitebox Gore vent

Cables

Propeller Guard

Propeller

Jet

Anode

Other

#### Comments

eFoil Hours of use

Date

Name of Technician

Signature of Technician

Authorised Service Partner



## Maintenance schedule

### 500 HOURS / 5 YEAR SERVICE

WHICHEVER COMES FIRST

#### Inspected

Mast

Fuselage

Flitebox

Cables

Propeller Guard

Propeller

Jet

Flitecell Health

#### Replaced

Seals

Oil

Flitebox Gore vent

Cables

Propeller Guard

Propeller

Jet

Anode

Other

#### Comments

eFoil Hours of use

Date

Name of Technician

Signature of Technician

Authorised Service Partner

**Congratulations on becoming  
a Fliteboard owner.**

Now it's time to get out there and  
experience the freedom of Flite.



